

**SAFEMASTER STS
Safety Switch-
And Key Interlock System
Basic Unit
RX10B01M/K and RX10K01M/K**

**Translation
of the original instructions**



E. DOLD & SÖHNE KG
P.O. Box 1251 • D-78114 Furtwangen • Germany
Tel: +49 7723 6540 • Fax +49 7723 654356
dold-relays@dold.com • www.dold.com

0278287

Content

Symbol and Notes Statement.....	14
General Notes	14
Notes	14
Product Description Switch Modules	15
Safety Category.....	15
Mechanically Coded Actuators	15
Actuator J With Self-Adjustment	15
Actuator CS	15
Double Actuators	15
EC Type Tested.....	15
Actuator C With Angle Compensation	15
CW Bolt Actuator.....	15
Actuator Locking Force.....	15
Monitoring Of 2 Doors With One Unit	15
Mechanically Coded Key	16
Key Labeling	16
Protection Against Confinement	16
Variable Alignment / Assembly	16
Easy To Assemble	16
The Right Key To The Field Of Application	16
Lockable Key	16
Lock Out Tag Out (LOTO).....	16
Modular And Expandable System	16
Mountable On Mounting Plate	16
Push-In Connection Technology (Switch)	17
Plug Connectors	17
Pre-Assembled Cables.....	17
Product Description	19
Approvals and Markings	19
Function.....	19
Design and Operation.....	20
Indications	20
Circuit Diagrams RX10B01M/K	20
Circuit Diagrams RX10K01M/K.....	20
Mechanical Switch Positions RX10B01M/K.....	21
Mechanical Switch Positions RX10K01M/K.....	21
Technical Data	22
Safety Related Data	22
Ordering Example.....	23
Variants and Combination Options	23
Ordering Example.....	23
Dimensional Drawing [mm].....	24

Symbol and Notes Statement



DANGER:
Indicates that death or severe personal injury will result if proper precautions are not taken.



WARNING:
Indicates that death or severe personal injury can result if proper precautions are not taken.



CAUTION:
Indicates that a minor personal injury can result if proper precautions are not taken.



INFO:
Referred information to help you make best use of the product.



ATTENTION:
Warns against actions that can cause damage or malfunction of the device, the device environment or the hardware / software result.

General Notes

The product hereby described was developed to perform safety functions as a part of a whole installation or machine. A complete safety system normally includes sensors (SAFEMASTER STS/K System), evaluation units, signals and logical modules for safe disconnections. The manufacturer of the installation or machine is responsible for ensuring proper functioning of the whole system. DOLD cannot guarantee all the specifications of an installation or machine that was not designed by DOLD. The total concept of the control system into which the device is integrated must be validated by the user. DOLD also takes over no liability for recommendations which are given or implied in the following description. The following description implies no modification of the general DOLD terms of delivery, warranty or liability claims.

Notes



Risk!

Danger to life or risk of serious injuries.

- Hazards must be ruled out before a key can be entered and the movable part of the guard can then be opened!



INFO

- For information regarding use in the system and validation according to EN ISO 13849-2, see SAFEMASTER STS application guide.
- Take advantage of the advice of the **E. DOLD & SÖHNE KG** specialists regarding the choice of units and combination of a system.



ATTENTION !

- To avoid wrong usage (e.g. by overload, mounting position or usage in acid, alkaline or other hostile ambient conditions) the limitations of the product have to be observed. Please check in advance if your application requires the usage of the more robust stainless steel model of SAFEMASTER STS. The requirements of the mounting and operating instruction must be fulfilled.



Before installing, operating or maintaining this device, these instructions must be carefully read and understood.



The installation must only be done by a qualified electrician!



The installation must only be done by a qualified mechanic!



Do not dispose of household garbage!
The device must be disposed of in compliance with nationally applicable rules and requirements.



Storage for future reference.

To help you understand and find specific text passages and notes in the operating instructions, we have important information and information marked with symbols.

Product Description Switch Modules

Safety switches of the SAFEMASTER STS series (FRP) reliably protect accesses and safety doors or flaps and are suitable for safety applications up to Cat. 4 / PL e according to EN ISO 13849-1 without fault exclusion. They are ideal for applications requiring a high level of security. The very narrow design also allows space-saving mounting on movable guards.

Safety Category

Up to

Cat. 4 / PL e SIL 3

SAFEMASTER STS/K systems can be used as individual solutions in applications up to category 4, Performance Level e according to EN ISO 13849-1 can be used.

EC Type Tested



SAFEMASTER STS/K systems are logic units for safety functions according to Annex IV, S21 and are EC type tested in accordance with legal requirements.

Mechanically Coded Actuators

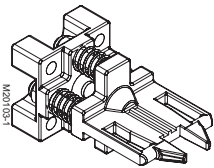

All actuators belonging to the SAFEMASTER STS/K system are also available in the coding level medium, according to EN ISO 14119:2013.

Actuator C With Angle Compensation

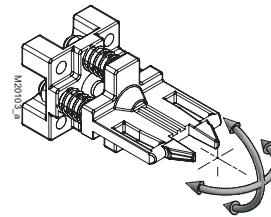

The C actuator with adjustable actuator angle is spring-mounted. It returns to its set state after a load.

Actuator J With Self-Adjustment

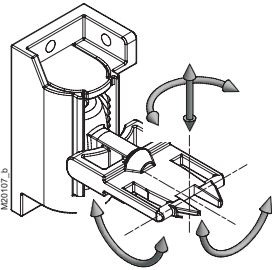

When plugged in, the J actuator is self-adjusting over 4 degrees of freedom and retains its last alignment state. It can have an offset of up to 20 mm to compensate.

CW Bolt Actuator

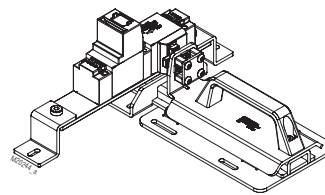

The CW bolt moves under the mounted unit, making the slider suitable for securing hinged doors with both left and right stop. It is designed in such a way that shear forces cannot act directly on the STS/K unit. It is particularly suitable for applications, where high forces can act on the STS/K units, e.g. in double swing doors.

Actuator CS

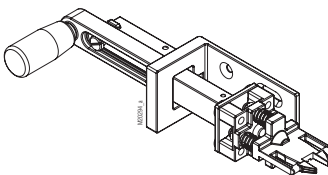

The CS actuator is particularly suitable for harsh and dirty ambient conditions. In addition, the CS actuator is designed for applications with high shear and tensile forces, so that overload breaks can be largely excluded.

Actuator Locking Force

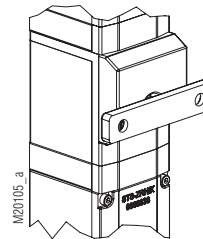

The holding force F_{zh} according to EN ISO 14119:2013 is 2000 N.

(stainless steel versions 4000 N)

Double Actuators

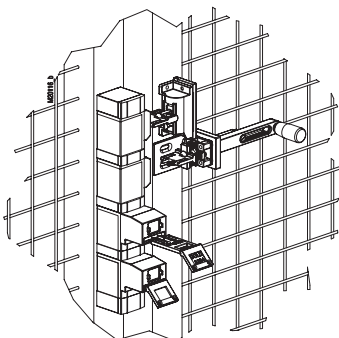

For applications with Performance Level e, SAFEMASTER STS/K units can also be equipped with 2 actuators.

Monitoring Of 2 Doors With One Unit

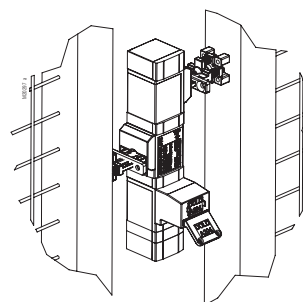

SAFEMASTER STS/K units with double actuators can be used to monitor 2 adjacent accesses.

Mechanically Coded Key

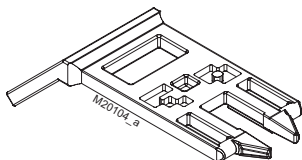

More than 50,000 codes are available for the keys of the SAFEMASTER STS/K system.

The Right Key To The Field Of Application

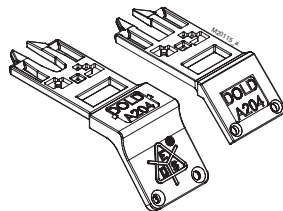

The SAFEMASTER STS/K system offers 2 different key designs.

Key Labeling

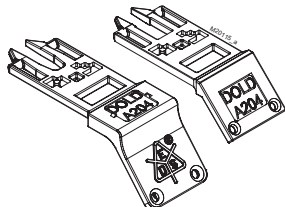

SAFEMASTER STS/K keys are labeled according to customer requirements. When plugged in, easily legible on the front side or on the top side when the key is removed.

Lockable Key

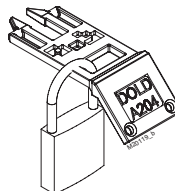

The keys of the SAFEMASTER STS/K system can be locked with padlocks.

Protection Against Confinement

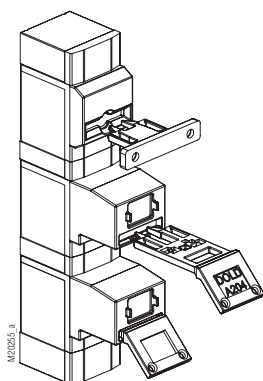

The keys can be removed and carried into the system as protection against lock-in. They also serve as protection against an unexpected restart of the machine.

Lock Out Tag Out (LOTO)

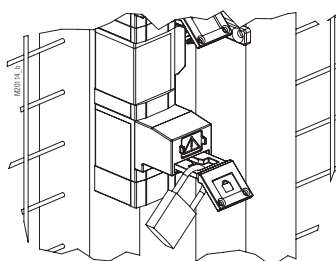

Lock Out Tag Out (LOTO) processes can be very well integrated into SAFEMASTER STS/K systems

Variable Alignment / Assembly

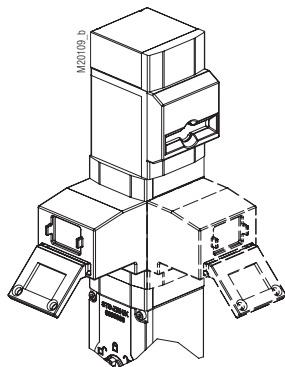

The modular design and the socket wrench principle allow a variable alignment of the modules. Keys and actuators can therefore also be operated from the side.

Modular And Expandable System

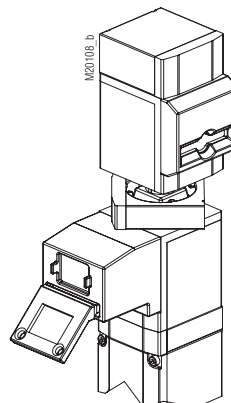

The modular design allows subsequent changes to the units or in the system

Easy To Assemble

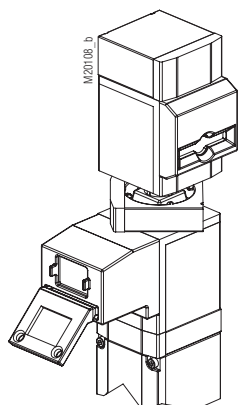

Units can be mounted easily and easily via ring locks (bayonet ring).

Mountable On Mounting Plate

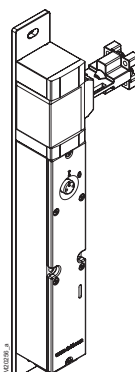

SAFEMASTER STS/K units can optionally be supplied on mounting plates. The alignment of the modules can be specified by the customer.

Push-In Connection Technology (Switch)

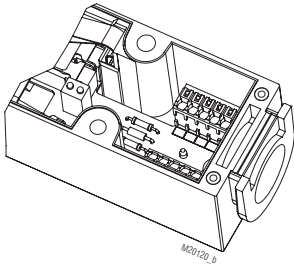

Wiring can be connected quickly and easily.
Up to 1 mm² (without ferrule).

Pre-Assembled Cables

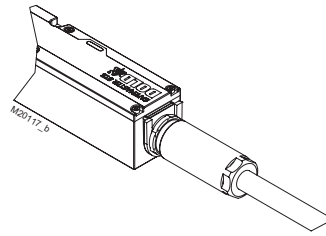

SAFEMASTER STS/K units are optionally available with pre-assembled and already connected cable in different lengths.

Plug Connectors

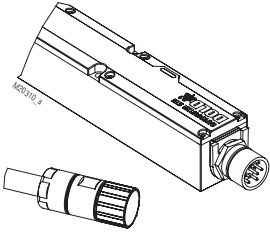

The SAFEMASTER STS/K switch modules can also be equipped with connectors.

SAFEMASTER STS/K Safety Switch- And Key Interlock System Basic Unit RX10B01M/K and RX10K01M/K

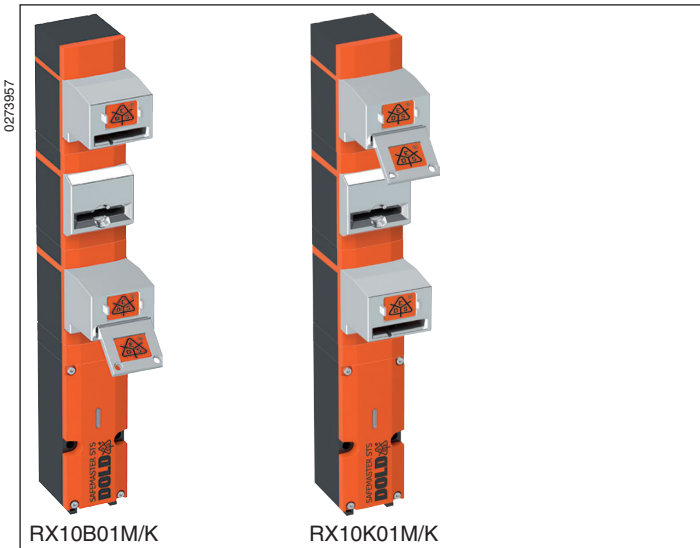

STS/K-System Benefits

- EU-Test certificate according to the directive 2006/42/EG, annex IX
- For safety applications up to PLe / Cat. 4 acc. to DIN EN ISO 13849-1
- Modular and expandable system
- Rugged composite version of stainless steel and FRP design
- Wireless mechanical safeguarding
- Combines the benefits of safety switch, solenoid locking and key transfer in a single system
- Easy installation through comprehensive accessories
- Protection against lock-in
- Coding level low, medium, high according to DIN EN ISO 14119:2014-03

Features

The unit is particularly suitable for applications with:

- Full body access (lock-in danger)
- Optional key removal
- Several secured entries
- Rugged ambient conditions
- This unit is also available in stainless steel

RX10B01M/K: Display in deactivated state:

1. key removed; actuator and 2. key inserted

RX10K01M/K: Display in deactivated state:

1. key inserted; actuator and 2. key removed

Approvals and Markings



Product Description

Mechanical solenoid lockings for separating guards with forced key entry and optional key removal as well as electrical monitoring function. To secure separating guards such as safety gates and hoods in machine and plant engineering.

Function

RX10B01M/K: Mechanical guard locking with monitoring of the first or second key

After the first key has been inserted, the actuator and then the second key can be removed.

With the variant RX10B01M/K, the contacts switch when the first key is inserted, while with the variant RX10K01M/K the contacts switch when the second key is removed.

Both versions are available with actuators of coding level low and medium according to EN ISO14119:2013. The coding level medium can be retrofitted. The second key can be used as part of a key transfer system or as a personal key, i.e. as protection against confinement and unexpected restart. Multiple keys make it possible to operate several units in the system or to protect several people. The RX10B01M/K and RX10K01M/K units can be expanded with additional key modules both below and above the actuator module. By using personal keys, an escape release (ISO TS19837:2017) can normally be dispensed with.

Both variants can optionally be equipped with padlock modules. These units can be connected to the SAFEMASTER STS option module, which includes command functions and is designed for wiring cross sections up to 1.5 mm².

Design and Operation

Attention!



Hazards must be ruled out before the movable part of the guard can then be opened! and the dangerous location can be reached!

Optionally, another key can be removed. The STS/K switch units are to be integrated into a system and connected with a control unit so that the hazardous machine can run only when the guard is locked and closed.

After entering a first key into key module 10/K (RX10B01M/K) the contacts switch and the actuator can be removed from actuator module B/K and the access can thus be opened. The first key is blocked and the second key released after removing the actuator. The actuator is blocked when the second key is removed from key module 01/K. This ensures an escape route. Only after the second key and the actuator (access is locked) were returned to their starting position can the first key be removed again and the solenoid locking is activated.

With the RX10K01M/K, the first key is inserted into key module 1 and the actuator can be removed. After removing the actuator, the 2nd key can be removed. When the 2nd key is removed, the contact switch and the actuator is blocked.

RX10B01M/K and RX10K01M/K are used in the system in connection with additional STS/K units and SAFEMASTER products. The first key to be entered may originate from these units (e.g. release through upstream solenoid locking ZRH01BM/K in connection with a speed monitor UH 5947 or standstill monitor LH 5946). The second key, optionally to be removed, can serve as protection against lock-in or for the operating release of additional units (e.g. M10BM/K, M11BM/K, M12M/K, M10B01M/K). On the base unit RX10B01M/K the key can be also be used as an authorization key.

Indications

LED red/green

Separately controllable

Circuit Diagrams RX10B01M/K

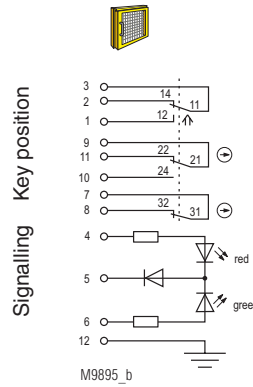

Fig. 1:
Locked while activated:
1st key removed, Actuator inserted,
2nd key inserted, Door closed

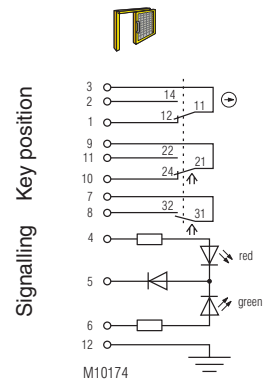

Fig. 2:
Lock deactivated:
1st key inserted, Actuator removed,
2nd key removed, Door open

RX10B01M/K

Mechanical Switch Positions			Fig. M1, M2
Circuit Diagram		Fig. 1	Fig. 2
Key contacts	3	2	
	3	1	
	9	10	
	9	11	
	7	8	

■ closed
□ open

Circuit Diagrams RX10K01M/K

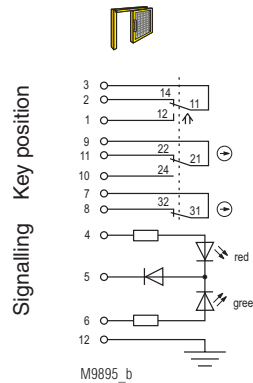

Fig. 1:
Lock deactivated:
1st key inserted, Actuator removed,
2nd key removed, Door open

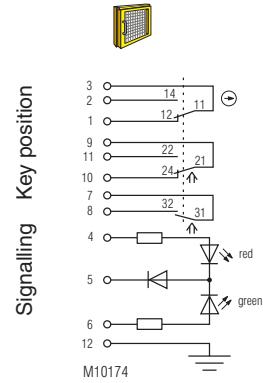
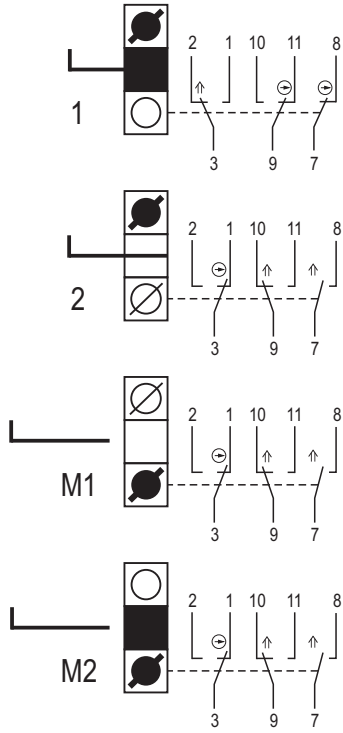

Fig. 2:
Locked while activated:
1st key removed, Actuator inserted,
2nd key inserted, Door closed

RX10K01M/K

Mechanical Switch Positions		Fig. M1, M2	
Circuit Diagram		Fig. 1	Fig. 2
Key contacts	3	2	
	3	1	
	9	10	
	9	11	
	7	8	







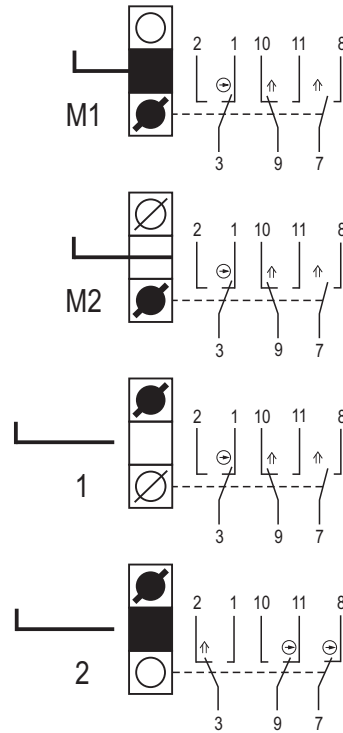

■ closed
□ open



M20287_b



M20288_b

	Coded key captive	Removal not possible
	Coded key plugged	Removal possible
	Coded key extracted	Plugging possible
	Coded key extracted and blocked	Plugging in not possible
	Actuator captive	Removal not possible
	Actuator plugged	Removal possible
	Actuator extracted	Plugging in possible
	Actuator extracted and blocked	Plugging in not possible

Technical Data

Mechanical Data

Mechanical principle:	Rotating axis with redundant actuation
Enclosure:	PA + GF
Internal parts:	Stainless steel V4A / AISI 316 (acc. to EN 10027-2; 1.4401; 1.4404; 1.4542; 1.4301; 1.4310)
Locking force:	F _{zh} 2000 N
Degree of protection:	IP 65
Operating speed:	
min. / max.:	100 / 250 mm/s

Input

Nominal voltage U_N (Rated voltage):	AC/DC 24 V
Nominal voltage range:	0.85 ... 1.1 U _N
Power consumption:	0.3 W

Output

Contacts:	1 NC contact, 2 antivalent changeover contacts
Switching element:	IEC EN 60947-5-1 Appendix K
Switching principle:	Changeover contact with forced opening spring contact
Contact material:	Ag / AgSnO ₂
Max. switching frequency:	360/h
Max. operating current:	2 A
Utilization category of switching elements	
to AC 15:	1 A
to DC 13:	0.5 A
Electrical service life:	5 x 10 ⁶ switching cycles
Short circuit strength,	
Max. fuse rating:	2 A gG
Courant nominal de court-circuit conditionnel (rated conditional short circuit current):	1000 A
Mechanical life:	1 x 10 ⁶ switching cycles

General Data

Temperature range:	- 25°C to + 45°C
Storage temperature:	- 25°C to + 60°C
Rated impuls voltage:	0.8 kV
Rated insulation voltage:	≤ 50 V
Overvoltage category:	III
Pollution degree:	2
Connection:	Cage clamp terminals
Cross sections min. / max.:	0.25 / 0.75 mm ² (with ferrules and sleeve according to DIN 46228-4)
Cable entry with thread:	1 x M20x1.5
Intended use:	Up to max. cat. 4, PL e according EN ISO 13849-1
Mounting:	To DIN EN 50041
Test principles:	EN ISO 13849-1:2015 DIN EN ISO 14119:2014-03 EN 60947-5-1:2017 GS-ET-15:2015-05 GS-ET-19:2015-05 GS-ET-31:2010-02

Safety Related Data

Data suitable for the PFH _d summation method according to EN ISO13849-1: 2016				
Data according to EN ISO13849-1: 2016	RX10K01M/K, RX10B01M/K			RX10KK01M/K RX10K01M/K
Category	2	3	3	4
PL	d	d	e	e
PFH _D	4,24398E-09	2,73837E-09	2,17828E-09	2,50305E-10
T _{10D}	20	20	20	20
CCF required	65 ...100	85 ...100	85 ...100	85 ...100
B _{10d}	2 x 10 ⁶	2 x 10 ⁶	2 x 10 ⁶	2 x 10 ⁶
d _{op} (d/a)	365	365	365	365
h _{op} (h/d)	24	24	24	24
t _{cycle} (h)	1	1	1	1
n _{op}	8760	8760	8760	8760
Diagnosics Coverage ratio DC	60 %	60 %	90 %	99 %
Test interval	1 / year	1 / year	1 / month	1 / month

Category 2: The prerequisites for installation and integration into a category 2 architecture must be met

Category 3: The prerequisites for installation and integration into a category 3 architecture must be met

Category 4: The prerequisites for installation and integration into a category 4 architecture must be met, in particular 2 actuators must be used

PFH_D: When used as a „stand-alone unit“ (not as part of a key transfer system), the safety parameters in the table above apply

When used as part of a **key transfer system**:

- PFH_D total STS system = SUM PFH_{D1} + ... PFH_{Dn}

- Lowest category of a module = category of whole STS system

- Lowest DC of a module = DC entire STS unit



If the design of a unit is changed, the safety-related data may also change.

Ordering Example

STS- RX 10 B 01 M /K

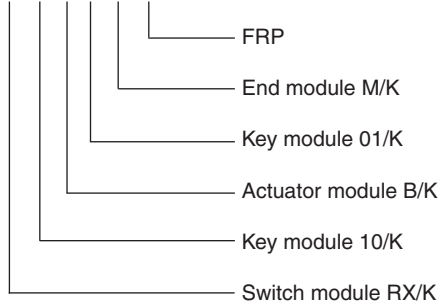

Ordering Example

STS- RX 10 K 01 M /K

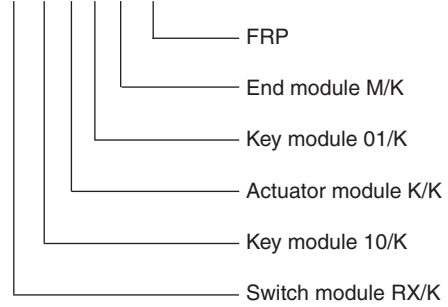

Variants and Combination Options

Because of their modular design the basic units of the SAFEMASTER STS/K System can be combined and expanded according to customer requests. This allows for a variety of possible units and functions.

Overview of the basic units

Functions	Safety switches design type 2	Safety switches design type 2 with solenoid lock	Mechanical units design type 2	Mechanical units with electrical monitoring	Mechanical units with electrical release
Units with standard function	SXBM/K	ZRHBM/K	M10BM/K	RXK01M/K RX10BM/K	YRXKM/K YRXK01M/K
Units with mechanical lock and forced key extraction	SX01BM/K	ZRH01BM/K	M11BM/K	RXK11M/K RX11BM/K	YRX10BM/K YRX11BM/K
Units with optional key extraction	SXB01M/K	ZRHB01M/K	M10B01M/K	RX10B01M/K RX10K01M/K	YRX10B01M/K
Units without actuator	SX01M/K	ZRH01M/K	M12M/K	RX11M/K	YRX11M/K

For additional information refer to the data sheets of the individual modules and other basic units.

Data sheets

Switching module RX/K
Key module 01/K / 10/K
Actuator module B/K
Actuator module K/K
End module M/K



Take advantage of the advice of the **E. DOLD & SÖHNE KG** specialists regarding the choice of units and combination of a system.

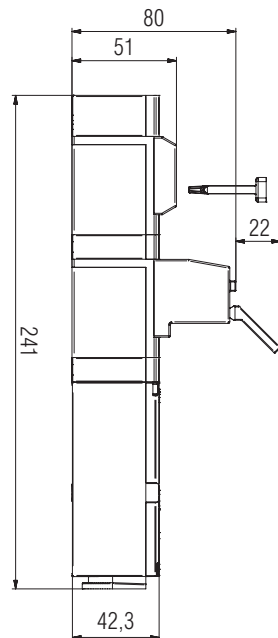
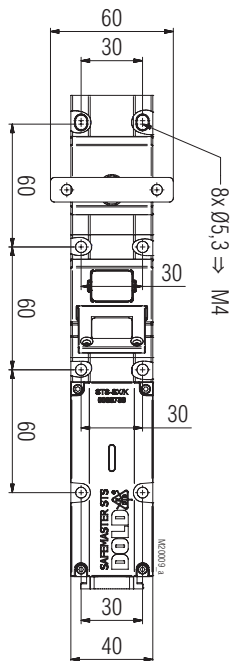
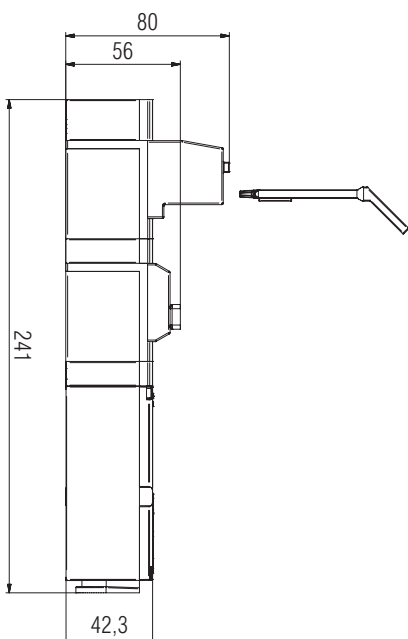
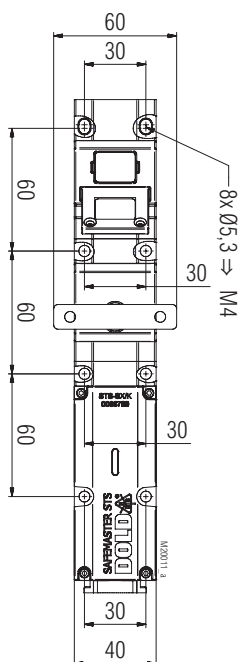
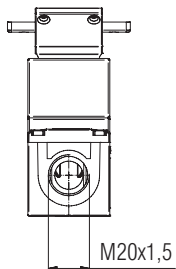
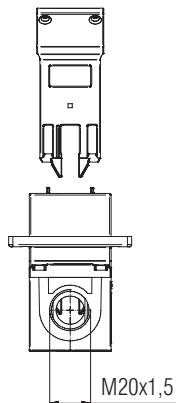

RXK01M/K
Clearance tolerances ± 2%

RX10BM/K
Clearance tolerances ± 2%

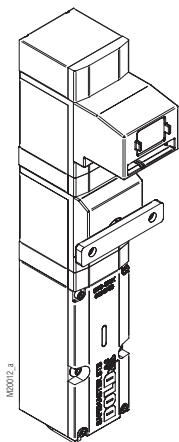

RXK01M/K

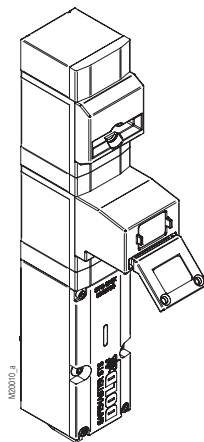

RX10BM/K