



SAFEMASTER STS/K
Safety switch-
and key interlock system
Basic unit
ZRHB01M/K

Translation
of the original instructions

0278300



E. DOLD & SÖHNE KG
P.O. Box 1251 • D-78114 Furtwangen • Germany
Tel: +49 7723 6540 • Fax +49 7723 654356
dold-relays@dold.com • www.dold.com

Content

Symbol and Notes Statement.....	14
General Notes	14
Notes	14
Product Description Locking Modules	15
Safety Category.....	15
Mechanically Coded Actuators	15
Actuator J With Self-Adjustment	15
Actuator CS	15
Double Actuators	15
EC Type Tested.....	15
Actuator C With Angle Compensation	15
CW Bolt Actuator.....	15
Actuator Locking Force.....	15
Monitoring Of 2 Doors With One Unit (Electrical)	15
Mechanically Coded Key	16
Key Labeling	16
Protection Against Confinement	16
Variable Alignment / Assembly	16
Easy To Assemble	16
The Right Key To The Field Of Application	16
Lockable Key	16
Lock Out Tag Out (LOTO).....	16
Modular And Expandable System	16
Mountable On Mounting Plate	16
Push-In Connection Technology (Guard Locking)	17
Plug Connectors	17
Emergency Unlocking.....	17
Pre-Assembled Cables.....	17
Mechanical Release	17
Lid With Integrated Command Functions	17
Product Description	19
Approvals and Markings	19
Function.....	19
Design and Function.....	20
Indication	20
Circuit Diagrams	20
Mechanical Switch Positions ZRHB01M/K	21
Technical Data	22
Safety Related Data	22
Solenoid Derating Graph	23
Variants and Combination Options	23
Ordering Example.....	23
Dimensional drawings [mm]	24



Before installing, operating or maintaining this device, these instructions must be carefully read and understood.



The installation must only be done by a qualified electrician!



The installation must only be done by a qualified mechanic!



Do not dispose of household garbage!
The device must be disposed of in compliance with nationally applicable rules and requirements.



Storage for future reference.

To help you understand and find specific text passages and notes in the operating instructions, we have important information and information marked with symbols.

Symbol and Notes Statement



DANGER:
Indicates that death or severe personal injury will result if proper precautions are not taken.



WARNING:
Indicates that death or severe personal injury can result if proper precautions are not taken.



CAUTION:
Indicates that a minor personal injury can result if proper precautions are not taken.



INFO:
Referred information to help you make best use of the product.



ATTENTION:
Warns against actions that can cause damage or malfunction of the device, the device environment or the hardware / software result.

General Notes

The product hereby described was developed to perform safety functions as a part of a whole installation or machine. A complete safety system normally includes sensors (SAFEMASTER STS/K System), evaluation units, signals and logical modules for safe disconnections. The manufacturer of the installation or machine is responsible for ensuring proper functioning of the whole system. DOLD cannot guarantee all the specifications of an installation or machine that was not designed by DOLD. The total concept of the control system into which the device is integrated must be validated by the user. DOLD also takes over no liability for recommendations which are given or implied in the following description. The following description implies no modification of the general DOLD terms of delivery, warranty or liability claims.

Notes



Risk!
Danger to life or risk of serious injuries.

- Hazards must be ruled out before a key can be entered and the movable part of the guard can then be opened!



INFO

- For information regarding use in the system and validation according to EN ISO 13849-2, see SAFEMASTER STS application guide.
- Take advantage of the advice of the **E. DOLD & SÖHNE KG** specialists regarding the choice of units and combination of a system.



ATTENTION !

- To avoid wrong usage (e.g. by overload, mounting position or usage in acid, alkaline or other hostile ambient conditions) the limitations of the product have to be observed. Please check in advance if your application requires the usage of the more robust stainless steel model of SAFEMASTER STS. The requirements of the mounting and operating instruction must be fulfilled.

Product Description Locking Modules

Guard locking devices of the SAFEMASTER STS/K (FRP) family combine the proven operating principle and the advantages of electromechanical safety switches with 2-channel guard locking function. Thanks to guard lock monitoring, they can be used for both process and reliable personal protection. Different coding levels, very high locking forces and extensive diagnostic options enable use in almost any safety-relevant application.

Safety Category

Up to

Cat. 4 / PL e SIL 3

SAFEMASTER STS/K systems can be used as individual solutions in applications up to category 4, Performance Level e according to EN ISO 13849-1 can be used.

EC Type Tested



SAFEMASTER STS/K systems are logic units for safety functions according to Annex IV, S21 and are EC type tested in accordance with legal requirements.

Mechanically Coded Actuators

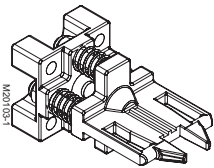

All actuators belonging to the SAFEMASTER STS/K system are also available in the coding level medium, according to EN ISO 14119:2013.

Actuator C With Angle Compensation

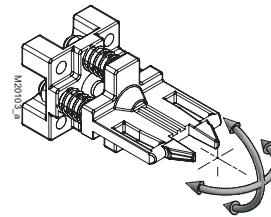

The C actuator with adjustable actuator angle is spring-mounted. It returns to its set state after a load.

Actuator J With Self-Adjustment

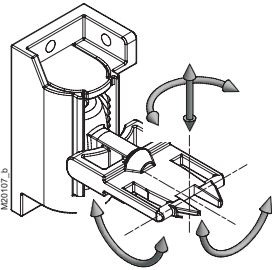

When plugged in, the J actuator is self-adjusting over 4 degrees of freedom and retains its last alignment state. It can have an offset of up to 20 mm to compensate.

CW Bolt Actuator

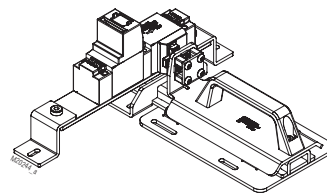

The CW bolt moves under the mounted unit, making the slider suitable for securing hinged doors with both left and right stop. It is designed in such a way that shear forces cannot act directly on the STS/K unit. It is particularly suitable for applications, where high forces can act on the STS/K units, e.g. in double swing doors.

Actuator CS

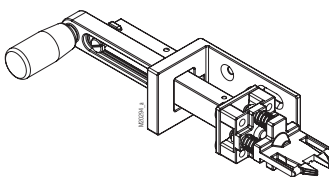

The CS actuator is particularly suitable for harsh and dirty ambient conditions. In addition, the CS actuator is designed for applications with high shear and tensile forces, so that overload breaks can be largely excluded.

Actuator Locking Force

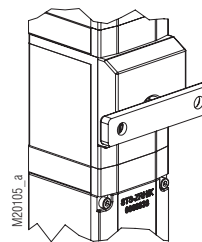

The holding force F_{zh} according to EN ISO 14119:2013 is 2000 N.

(stainless steel versions 4000 N)

Double Actuators

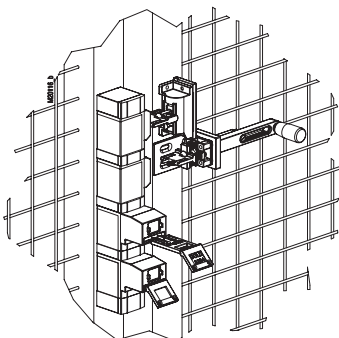

For applications with Performance Level e, SAFEMASTER STS/K units can also be equipped with 2 actuators.

Monitoring Of 2 Doors With One Unit (Electrical)

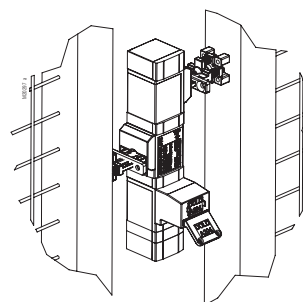

SAFEMASTER STS/K units with double actuators can be used to monitor 2 adjacent accesses.

Mechanically Coded Key

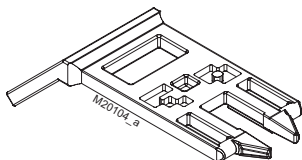

More than 50,000 codes are available for the keys of the SAFEMASTER STS/K system.

The Right Key To The Field Of Application

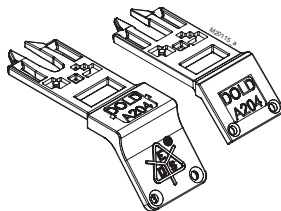

The SAFEMASTER STS/K system offers 2 different key designs.

Key Labeling

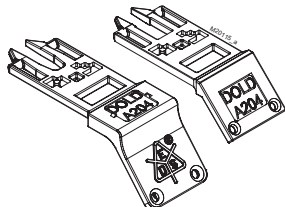

SAFEMASTER STS/K keys are labeled according to customer requirements. When plugged in, easily legible on the front side or on the top side when the key is removed.

Lockable Key

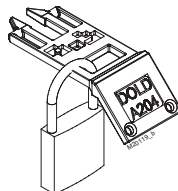

The keys of the SAFEMASTER STS/K system can be locked with padlocks.

Protection Against Confinement

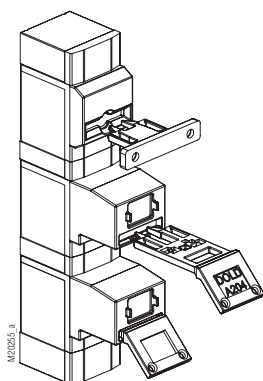

The keys can be removed and carried into the system as protection against lock-in. They also serve as protection against an unexpected restart of the machine.

Lock Out Tag Out (LOTO)

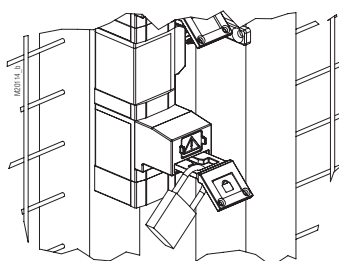

Lock Out Tag Out (LOTO) processes can be very well integrated into SAFEMASTER STS/K systems

Variable Alignment / Assembly

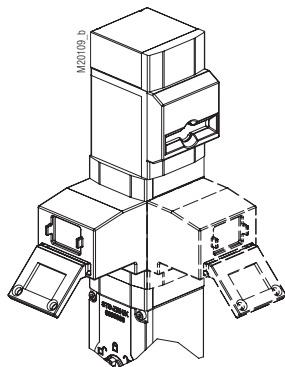

The modular design and the socket wrench principle allow a variable alignment of the modules. Keys and actuators can therefore also be operated from the side.

Modular And Expandable System

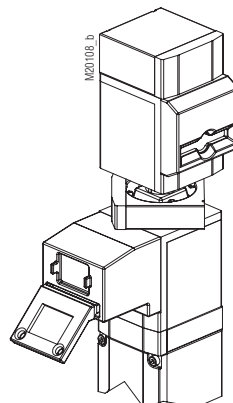

The modular design allows subsequent changes to the units or in the system

Easy To Assemble

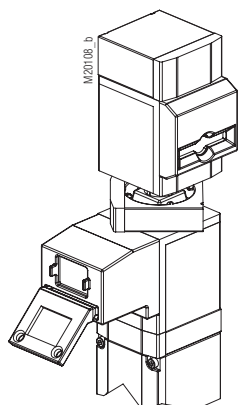

Units can be mounted easily and easily via ring locks (bayonet ring).

Mountable On Mounting Plate

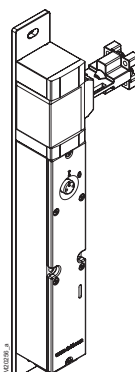

SAFEMASTER STS/K units can optionally be supplied on mounting plates. The alignment of the modules can be specified by the customer.

Push-In Connection Technology (Guard Locking)

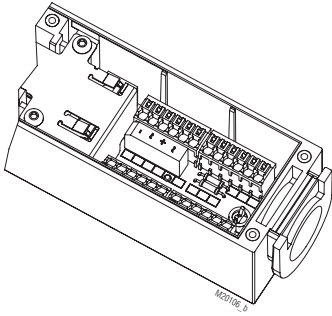

The screwless connection technology enables fast wiring.

Up to 1 mm² (without ferrule).

Pre-Assembled Cables

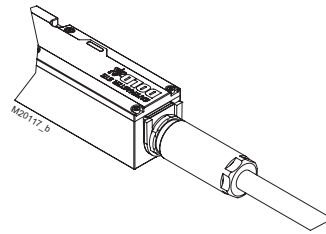

SAFEMASTER STS/K units are optionally available with pre-assembled and already connected cable in different lengths.

Plug Connectors

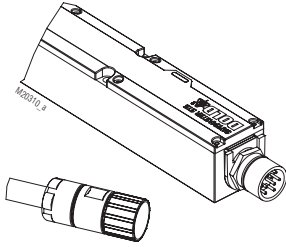

The SAFEMASTER STS/K locking modules can also be equipped with connectors.

Mechanical Release

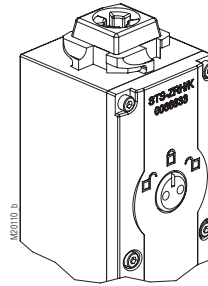

The SAFEMASTER STS/K locking modules with mechanical release permit release even in the event of a power failure

Emergency Unlocking

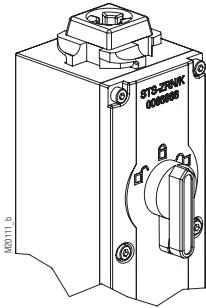

The SAFEMASTER STS/K locking modules with emergency unlocking can be used there, where people locked up must be rescued. If the release can be reached within the danger zone, it can also be used as an emergency release.

Lid With Integrated Command Functions

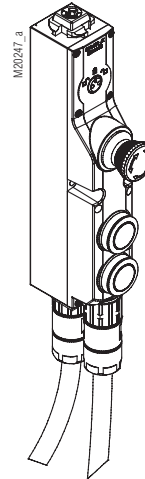

Functions such as emergency stop, start, stop can be integrated directly in the lid.

SAFEMASTER STS/K Safety switch- and key Interlock system Basic unit ZRHB01M/K



Presentation in the deactivated condition:
Actuator and key removed

STS/K-System Benefits

- EU-Test certificate according to the directive 2006/42/EG, annex IX
- For safety applications up to PLe / Cat. 4 acc. to DIN EN ISO 13849-1
- Modular and expandable system
- Rugged composite version of stainless steel and FRP design
- Wireless mechanical safeguarding
- Combines the benefits of safety switch, solenoid locking and key transfer in a single system
- Easy installation through comprehensive accessories
- Protection against lock-in
- Coding level low, medium, high according to DIN EN ISO 14119:2014-03

Features

The unit is particularly suitable for applications with:

- Full body access (lock-in danger)
- Several secured entries
- Single-channel / redundant / diverse safety circuits
- Rugged ambient conditions
- Required access permissions
- These units are also available in stainless steel

Approvals and Markings



Product Description

Switch with electromechanical guard locking, separate actuator, optional key removal and auxiliary release
When activated the contacts which monitor the disable position switch.
When the key is removed, the contacts for key monitoring switch and the actuator can be removed.

To secure separating guards such as safety gates and hoods in machine and plant engineering.

Function

Safety switch with forced key removal and electromagnetic blocking of the key

The ZRHB01M/K unit is available in accordance with EN ISO 14119:2013 with low and medium coding level actuators. The medium coding stages can be retrofitted. The key can be used as part of a key transfer system or as a personal key, i.e. as protection against confinement and unexpected restart. Multiple keys make it possible to operate several units in the system or to protect several people. For this purpose, the ZRHB01M/K unit can also be extended above the key module with additional key modules. By using personal keys, an escape release (ISO TS19837:2017) can normally be dispensed with.

Optionally the unit ZRHB01M/K without mechanical release can be equipped with emergency release. Padlock modules and key modules can also be added. Locking modules with emergency release have the designation ZRN/K module and without auxiliary or emergency release ZRX/K module.

This unit is also available with integrated command functions.

Design and Function

STS/K Solenoid locking units prevent opening of separating guards and keep them closed as long as there is a risk of injury in the secured plant.

Attention!



Hazards must be ruled out before a key can be removed and the movable part of the guard can then be opened!

The STS/K solenoid locking unit is to be integrated into a system and connected with a control unit so that the hazardous machine can run only when the guard is locked and closed.

An access can only be opened after a release signal was sent by the machine control to the ZRHB01M/K solenoid locking unit. The actuator can only be removed from actuator module B/K and the access opened after removing the key from key module 01/K. Key operation is not forced. Key entry is not blocked when the door is open. The key can be entered again after the access was closed again. Only after entering the key is the solenoid locking activated again and the machine can be restarted. Key and magnet position are monitored by separate contacts.

ZRHB01M/K is usually used in the system in connection with additional STS/K units and SAFEMASTER products (e.g. release by speed monitor UH 5947, standstill monitor LH 5946 or speed/standstill monitor BH 5932). The key with forced removal can be used as protection against lock-in.

Indication

LED red: Magnet energized
LED yellow/green: Magnet de-energized

Circuit Diagrams

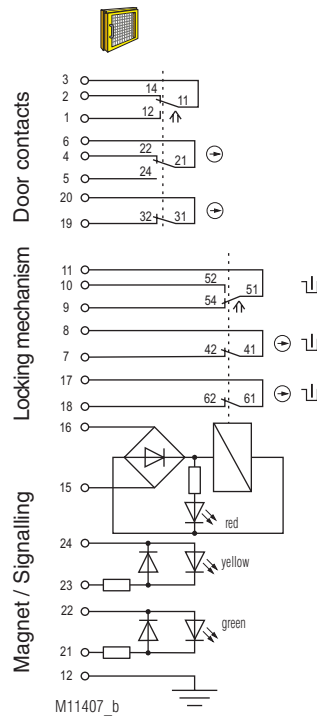

Fig. 1:
Solenoid locking activated:
Magnet locked,
Key inserted

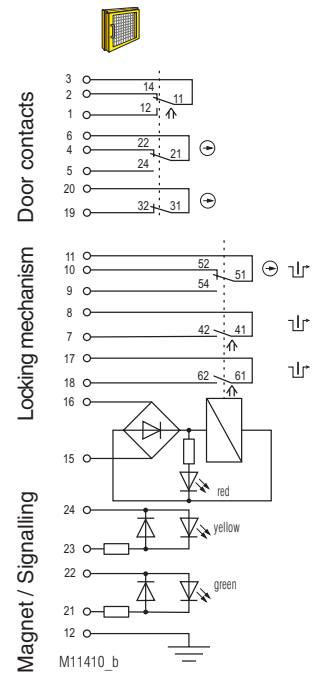

Fig. 2:
Solenoid locking deactivated:
Magnet released,
Key inserted

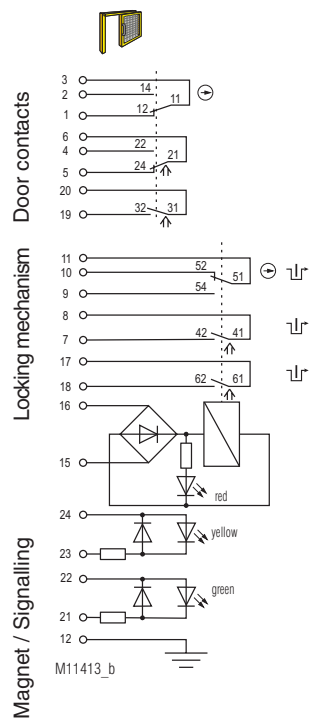

Fig. 3:
Solenoid locking deactivated:
Magnet released,
actuator removed

ZRHB01M/K, ZRHB02M/K

Mechanical Switch Positions				
	Fig. 1	Fig. 2	Fig. 3	Fig. M1, M2
Door contacts	3	2		
	3	1		
	6	4		
	6	5		
	19	20		
Locking mechanism	11	9		
	11	10		
	7	8		
Magnet / Signalling	De-energized on trip			
	15	16		
	Open circuit operation			
	15	16		
closed				
open				

The state shown in **Figure 3** does not depend on the control signal of the magnet.







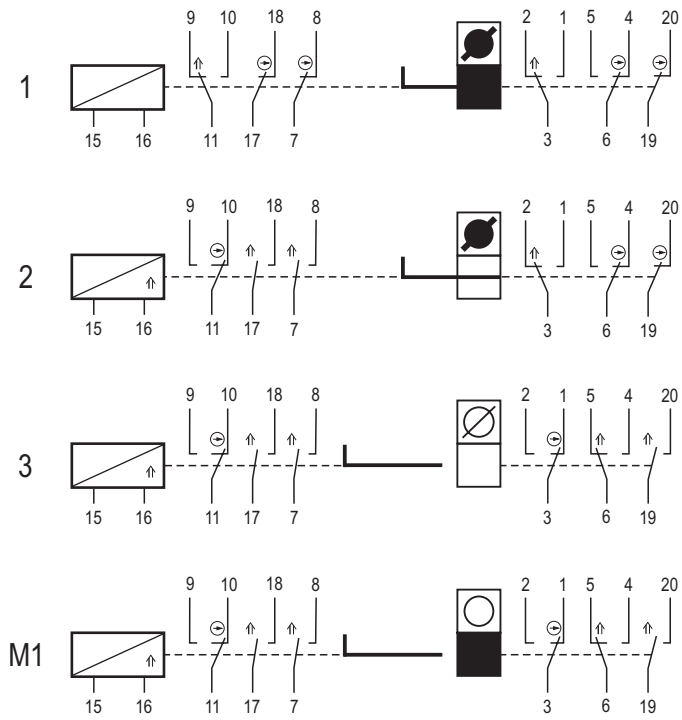

If the control signal is applied and the actuator inserted the solenoid locking changes to the state of **Figure 2**.

If no signal is applied and the actuator is inserted the solenoid locking changes to the state of **Figure 1**.

Mechanical Switch Positions ZRHB01M/K



M20276_b

	Coded key captive	Removal not possible
	Coded key plugged	Removal possible
	Coded key extracted	Plugging possible
	Coded key extracted and blocked	Plugging in not possible
	Actuator captive	Removal not possible
	Actuator plugged	Removal possible
	Actuator extracted	Plugging in possible
	Actuator extracted and blocked	Plugging in not possible

Technical Data

Mechanical Data

Mechanical principle:	Rotating axis with redundant actuation and mechanical interlock
Enclosure:	PA + GF
Internal parts:	Stainless steel V4A / AISI 316 (acc. to EN 10027-2; 1.4401; 1.4404; 1.4542; 1.4301; 1.4310)
Locking force:	F _{zh} 2000 N
Degree of protection:	IP 65
Locking module principle:	Standby current, failure locking-proof
Magnetic principle:	Standby current or load current
Operating speed min. / max.:	100 / 250 mm/s

Input

Nominal voltage U_N (Measured nominal voltage):	AC/DC 24 V
Nominal voltage range:	0.85 ... 1.1 U _N (see solenoid derating graph)
Power consumption:	5.5 W

Output

Contacts	
Door position:	1 NC contact, 2 antivalent changeover contacts
Locking mechanism:	2 NC contacts + 1 C/O contact
Switching element:	IEC EN 60947-5-1 Appendix K
Switching principle:	Changeover contact with forced opening spring contact
Contact material:	Ag / AgSnO ₂
Max. switching frequency:	360/h
Max. operating current	
De-energized on trip:	2 A
Energized on trip:	1 A
Utilization category of switching elements	
to AC 15:	1 A
to DC 13:	0.5 A
Electrical service life:	5 x 10 ⁶ switching cycles
Short circuit strength, max. fusing:	2 A gG
Courant nominal de court-circuit conditionnel (rated conditional short circuit current):	1000 A
Mechanical life:	1 x 10 ⁶ switching cycles

General Data

Operating mode	
Mechanical life:	100% ED
Temperature range	
Standby current principle:	- 25°C to + 45°C
Load current principle:	- 25°C to + 45°C
Storage temperature:	- 25°C to + 60°C
Rated impulse voltage:	0.8 kV
Rated insulation voltage:	≤ 50 V
Overvoltage category:	III
Pollution degree:	2
Connection:	Cage clamp terminals
Cross sections min. / max.:	0.25 / 0.75 mm ² (with ferrules and sleeve according to DIN 46228-4)
Cable entry with thread:	1 x M20x1.5
Intended use:	Up to max. cat. 4, PL e according EN ISO 13849-1
Mounting:	To DIN EN 50041
Test principles:	EN ISO 13849-1:2015 DIN EN ISO 14119:2014-03 EN 60947-5-1:2017 GS-ET-15:2015-05 GS-ET-19:2015-05 GS-ET-31:2010-02

Safety Related Data

Data suitable for the PFHd summation method according to EN ISO13849-1: 2016				
Data according to EN ISO13849-1: 2016	ZRH01M/K			ZRHBB01M/K
Category	2	3	3	4
PL	d	d	e	e
PFH _D	3.18299E-09	2.05378E-09	1.63371E-09	2.00244E-10
T _{10D}	20	20	20	20
CCF required	65 ...100	85 ...100	85 ...100	85 ...100
B _{10d}	2 x 10 ⁶	2 x 10 ⁶	2 x 10 ⁶	2 x 10 ⁶
d _{op} (d/a)	365	365	365	365
h _{op} (h/d)	24	24	24	24
t _{cycle} (h)	1	1	1	1
n _{op}	8760	8760	8760	8760
Diagnostics Coverage ratio DC	60 %	60 %	90 %	99 %
Test interval	1 / year	1 / year	1 / month	1 / month

Category 2: The prerequisites for installation and integration into a category 2 architecture must be met

Category 3: The prerequisites for installation and integration into a category 3 architecture must be met

Category 4: The prerequisites for installation and integration into a category 4 architecture must be met, in particular 2 actuators must be used

PFH_D: When used as a „stand-alone unit“ (not as part of a key transfer system), the safety parameters in the table above apply

When used as part of a **key transfer system**:

- PFH_D total STS/K system = SUM PFH_{D1} + ... PFH_{Dn}

- Lowest category of a module = category of whole STS/K system

- Lowest DC of a module = DC entire STS/K unit



If the design of a unit is changed, the safety-related data may also change.

Solenoid Derating Graph

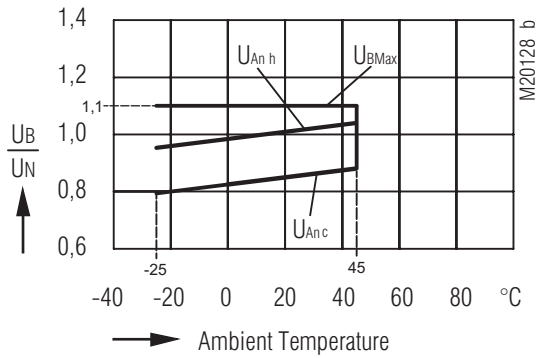

U_{BMax} maximum power supply dependent upon temperature
 U_{Anc} response voltage at coil temperature = ambient temperature
 U_{Anh} response voltage at preceding agitation at $1.1 \times U_n$

Ordering Example

STS- Z R H B 01 M /K

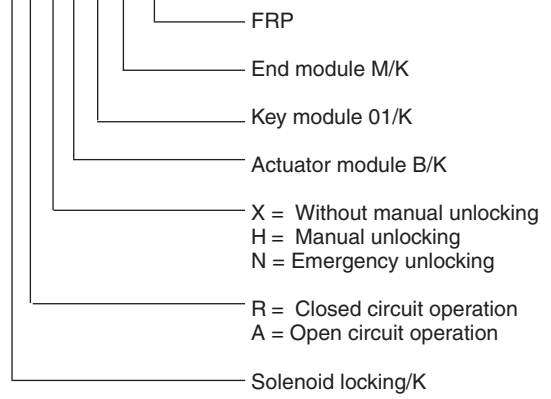

Variants and Combination Options

Because of their modular design the basic units of the SAFEMASTER STS/K System can be combined and expanded according to customer requests. This allows for a variety of possible units and functions.

Overview of the basic units

Functions	Safety switches design type 2	Safety switches design type 2 with solenoid lock	Mechanical units design type 2	Mechanical units with electrical monitoring	Mechanical units with electrical release
Units with standard function	SXBM/K	ZRHBM/K	M10BM/K	RXK01M/K RX10BM/K	YRXKM/K YRXK01M/K
Units with mechanical lock and forced key extraction	SX01BM/K	ZRH01BM/K	M11BM/K	RXK11M/K RX11BM/K	YRX10BM/K YRX11BM/K
Units with optional key extraction	SXB01M/K	ZRHB01M/K	M10B01M/K	RX10B01M/K RX10K01M/K	YRX10B01M/K
Units without actuator	SX01M/K	ZRH01M/K	M12M/K	RX11M/K	YRX11M/K

For additional information refer to the data sheets of the individual modules and other basic units.

Data sheets

Switching module ZRX/K / ZRH/K / ZAX/K
 Actuator module B/K
 Key module 01/K / 10/K
 End module M/K



Take advantage of the advice of the **E. DOLD & SÖHNE KG** specialists regarding the choice of units and combination of a system.

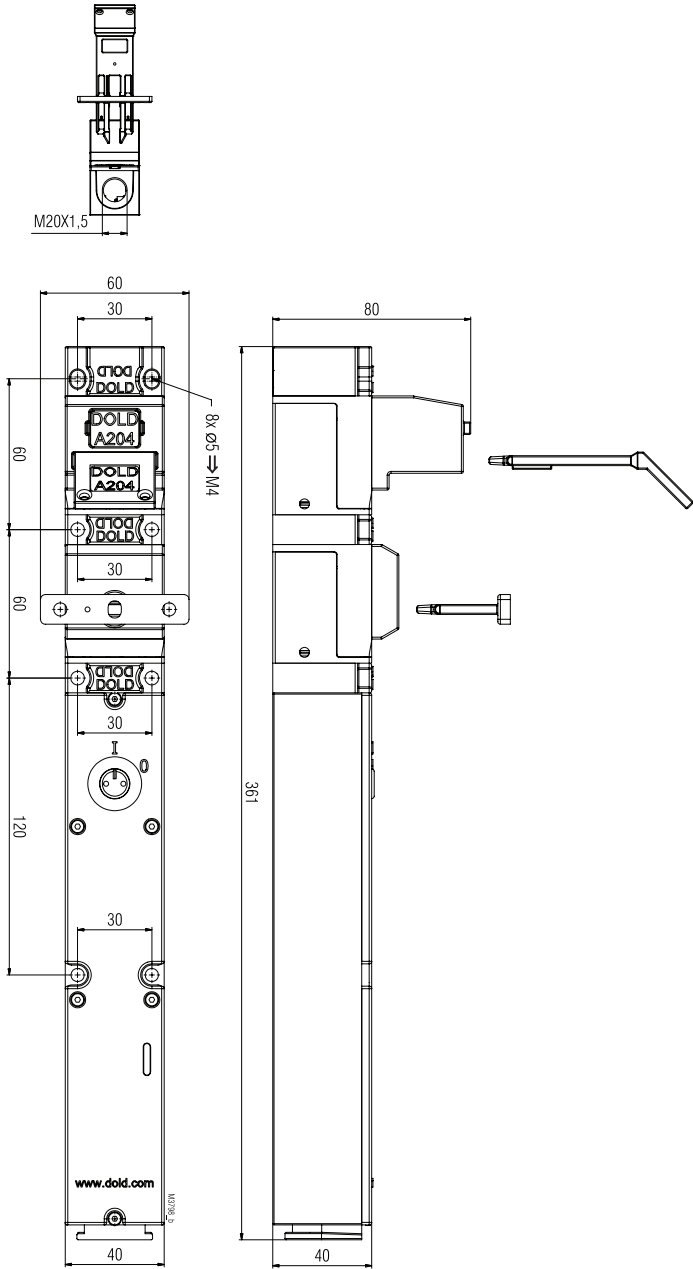

ZRHB01M/K
Clearance tolerances $\pm 2\%$

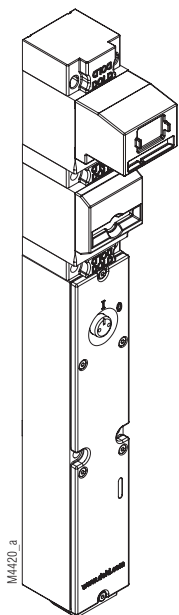

ZRHB01M/K